

C41

Water Cooled Resonant Capacitor

Water Cooled Resonant Capacitor C41-BB1



Characteristics

- Conduction water-cooled
- Polypropylene dielectric
- Low dissipation factor($\text{tg}\delta$), low ESL and low ESR
- High voltage, high frequency and high dv/dt
- High current resistance, excellent heat dissipation

Application

- Widely used in high power and high frequency resonant devices

Technical Data

● Reference standards	GB/T 3984-2004 IEC 60110.1
● Operating temperature range	-40°C~+85°C
● Capacitance range	0.1μF~85μF
● Rated capacitance	100kVar-1500 kVar
● Rated voltage	400VAC-1100VAC
● Tolerance	±5% ±10%
● Test voltage between terminals	1.5 U_{NAC} 10s
	3.5 U_{NDC} 10s at 25°C±5°C
● Dissipation factor	$\text{tg}\delta \leq 5 \times 10^{-4}$ at 25°C±5°C, 1kHz
● Insulation resistance	$R \cdot C \geq 3000\text{s}$, at 100VDC, 25°C±5°C, 60s
● Life expectancy	100000h at U_{N} and 70°C, 30000h at U_{rms}

Typical Circuit

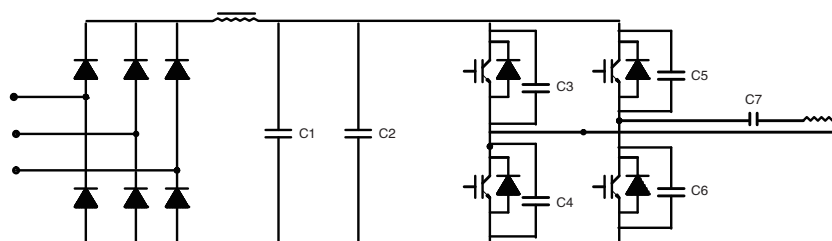

C7 is the water-cooled capacitor in the series resonant capacitor

C41

Water Cooled Resonant Capacitor

Construction Diagram

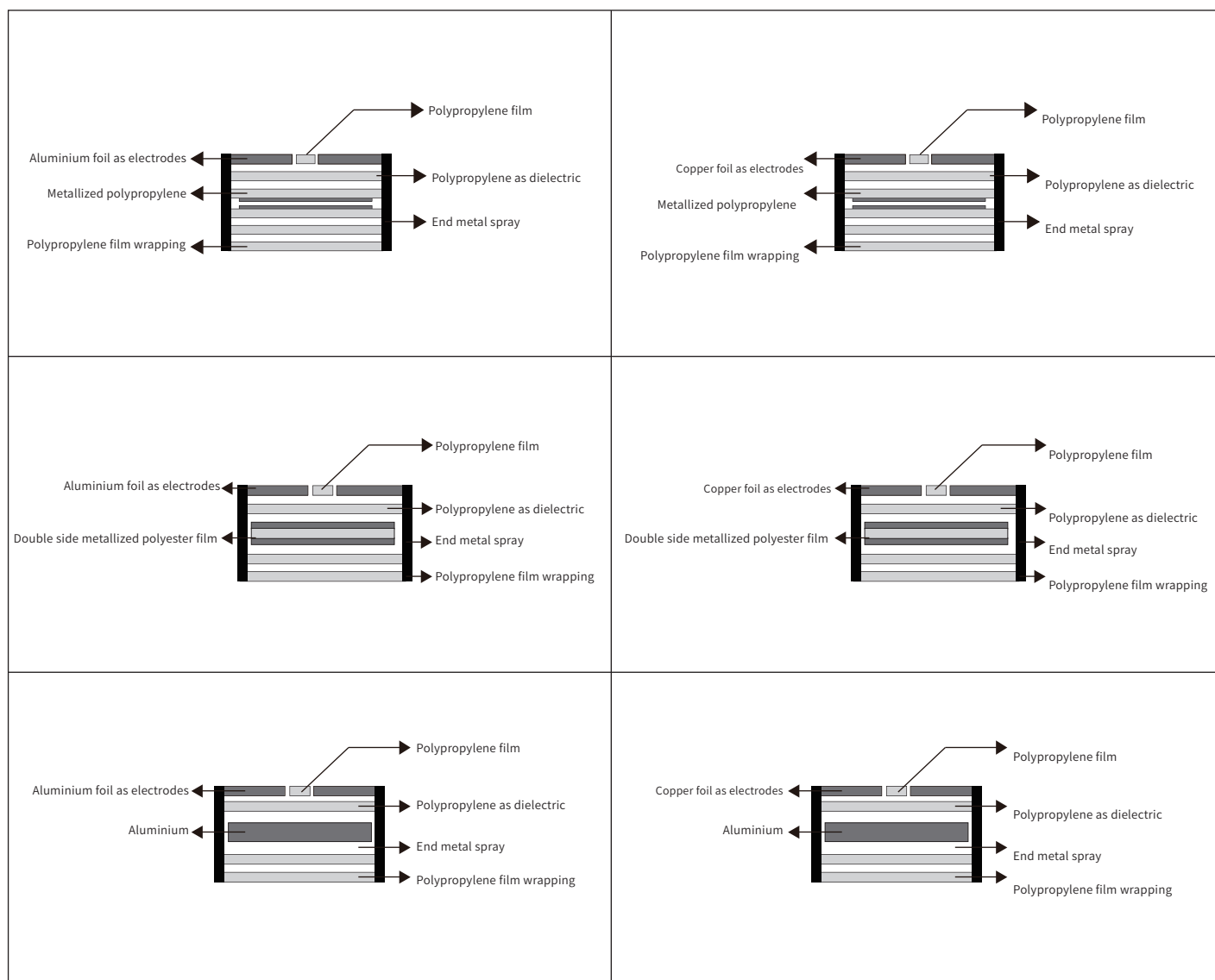

Product Coding

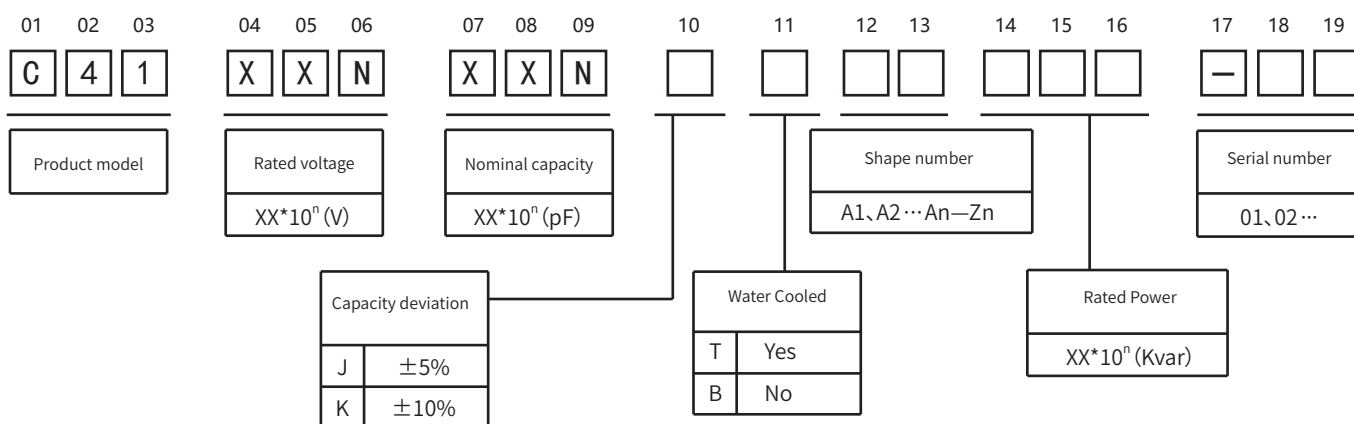

C41

Water Cooled Resonant Capacitor

C41-BB1

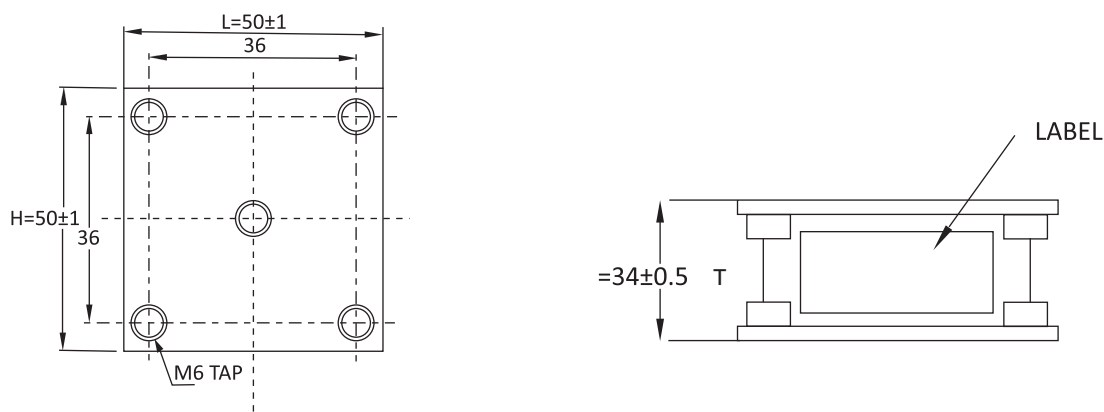

Article Table

Part Number	Rated Voltage Vrms	Nominal Capacitance μF at 1Khz	Max Irms A	Max Power kVar	Freq Range @Full Power (kHz)	ESR mΩ	Dimension (mm)			Case Code
							L	H	T	
C41701334KBB1201***	700	0.33	300	200	196-216	1.0	50	50	36	BB1
C41601664KBB1201***	600	0.66	350	200	135-149	0.8	50	50	36	BB1
C41501125KBB1201***	500	1.20	400	200	105-105	0.5	50	50	36	BB1
C41501155KBB1201***	500	1.50	400	200	85-108	0.3	50	50	36	BB1
C41401265KBB1201***	400	2.60	550	200	80-96	0.2	50	50	36	BB1

Part Number	Rated Voltage Vrms	Nominal Capacitance μF at 1Khz	Max Irms A	Max Power kVar	Freq Range @Full Power (kHz)	ESR mΩ	Dimension (mm)			Case Code
							L	H	T	
C41102104KBB1301...	1000	0.10	350	300	476-649	1.2	50	50	36	BB1
C41102204KBB1301...	1000	0.20	400	300	238-423	1.2	50	50	36	BB1
C41701254KBB1301...	700	0.25	500	300	390-530	1.2	50	50	36	BB1
C41701334KBB1301...	700	0.33	500	300	295-401	1.0	50	50	36	BB1
C41701664KBB1301...	700	0.66	500	300	147-200	0.8	50	50	36	BB1
C41601105KBB1301...	600	1.00	650	300	132-223	0.5	50	50	36	BB1
C41601125KBB1301...	600	1.20	650	300	111-187	0.5	50	50	36	BB1
C41601135KBB1301...	600	1.32	650	300	100-170	0.3	50	50	36	BB1
C41501245KBB1301...	500	2.40	650	300	80-97	0.2	50	50	36	BB1
C41102104KBB1301...	1000	0.10	350	300	476-649	1.2	50	50	36	BB1

C41

Water Cooled Resonant Capacitor

Temperature Characteristics

—◆— Voltage —■— Current —▲— Power

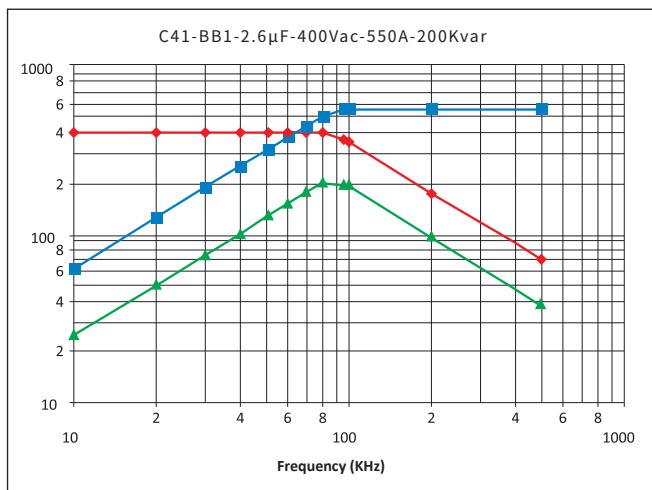
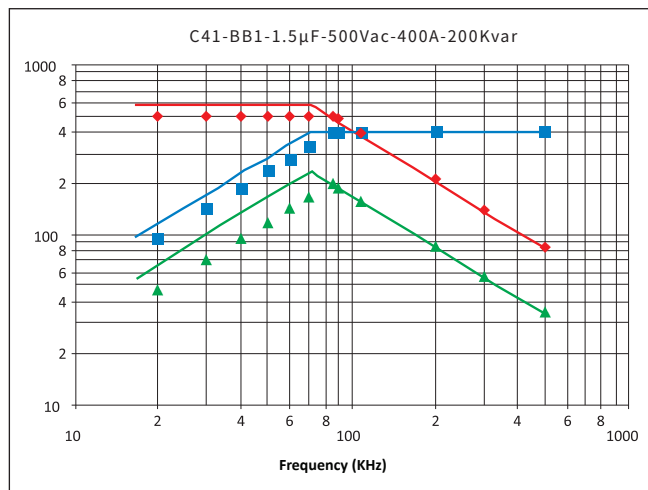
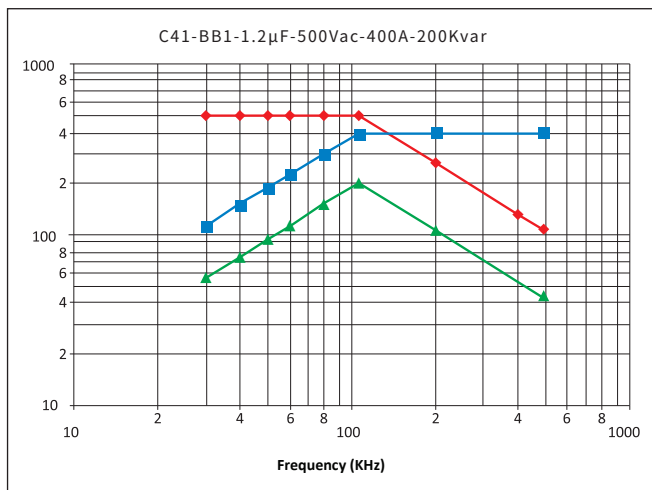
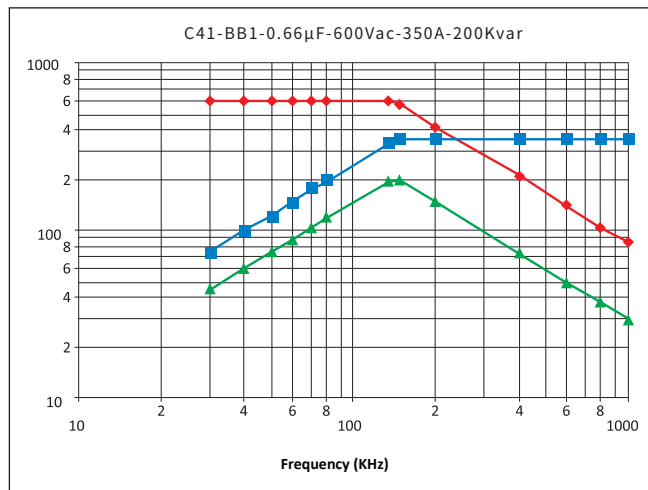
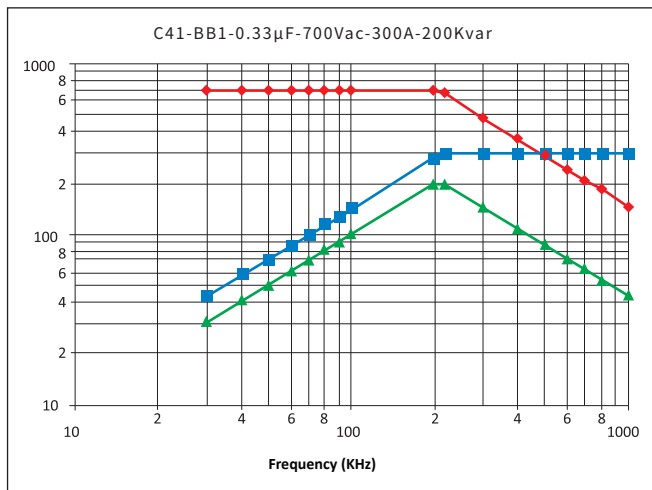

C41

Water Cooled Resonant Capacitor

Temperature Characteristics

—●— Voltage —■— Current —▲— Power

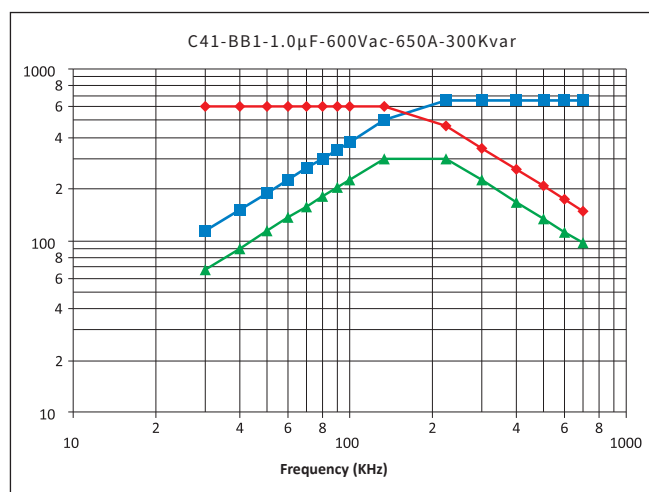
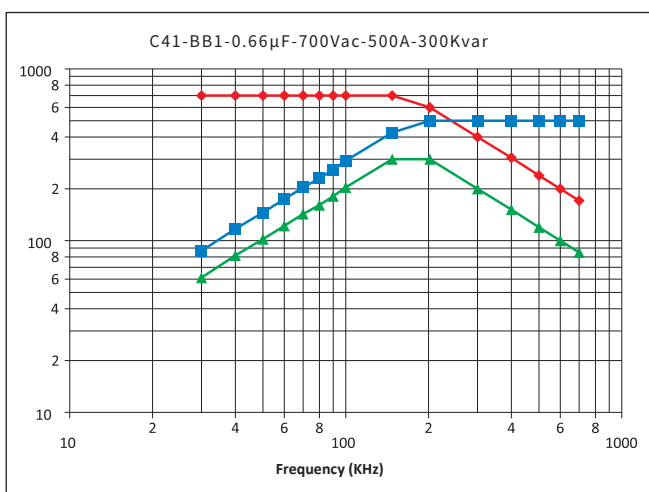
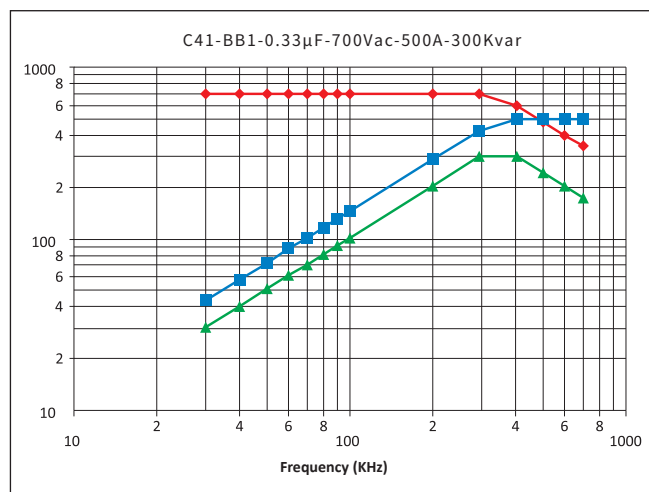
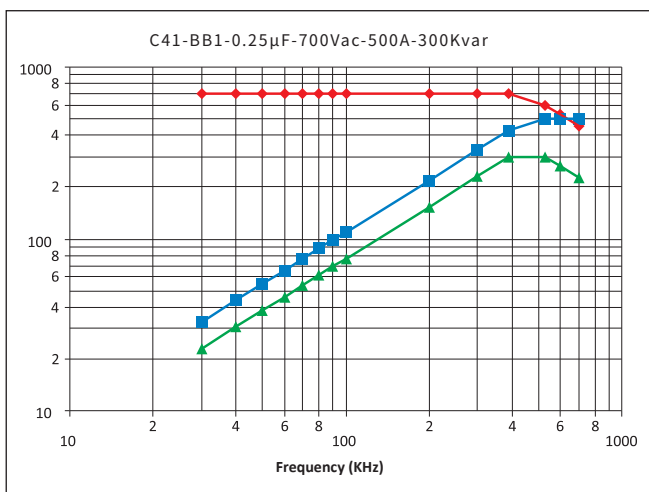
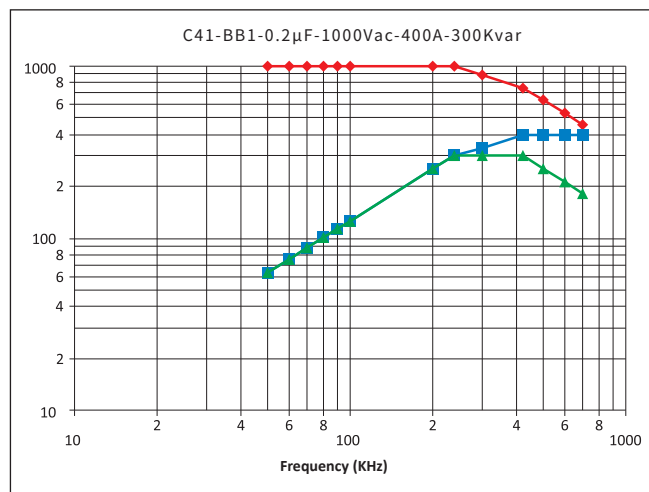
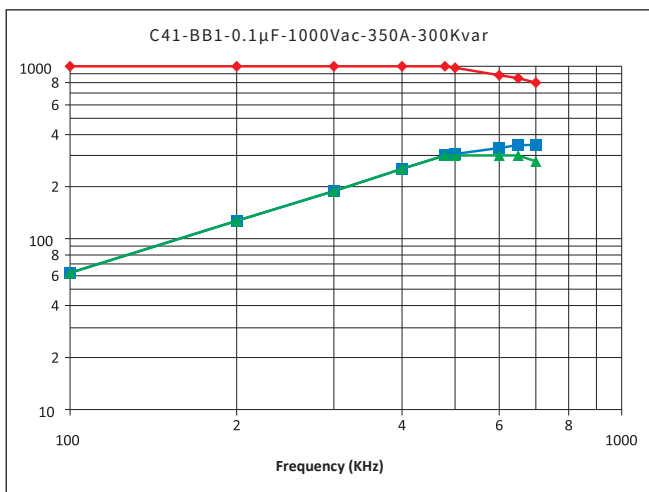

C41

Water Cooled Resonant Capacitor

Temperature Characteristics

—●— Voltage —■— Current —▲— Power

